

# Measurement of Kinematic Properties of Events with Photons in Proton-Antiproton Collisions (August 2009)

Jessica M. Smith

**Abstract**— Data from proton-antiproton collisions at the CDF experiment, collected from April 2005 to August 2007, are analyzed and compared to predictions of the Standard Model using a Monte Carlo simulation called PYTHIA. The Standard Model predicts that a small fraction of proton-antiproton collisions will produce an energetic photon, the force-carrying particle for electromagnetism, plus one or more quarks and gluons. The kinematic properties of photons and jets, which are produced from quarks or gluons, were analyzed. The CDF data agree very well with Standard Model predictions; however, minor differences were found. These differences are very likely to be due to the possible presence of background events in the data sample.

**Index Terms**—High Energy Physics, Standard Model, CDF, Monte Carlo

## I. INTRODUCTION

MATTER in the universe can be described in terms of elementary particles and the interactions that take place between these particles. This view of the universe is known as the Standard Model and the Standard Model has successfully predicted experimental measurements for decades. According to the Standard Model, the elementary particles can be categorized based on their intrinsic spin. Particles with half-integer spins (i.e.  $1/2$ ,  $3/2$ ,  $5/2$ , etc.) are called fermions and particles with integer spins (i.e. 0, 1, 2, etc.) are called bosons. The elementary fermions, called quarks and leptons, are the building blocks of the universe. The elementary bosons, called gauge bosons, govern the interactions between quarks and leptons and are known as “force-carriers”. Gauge bosons are responsible for the four fundamental forces: the electromagnetic force, the strong force, the weak force, and gravity.

There exist three generations of quarks and leptons. Generation 1 quarks are up and down, generation 2 quarks are charm and strange, and generation 3 quarks are top and bottom. Generation 1 leptons are the electron and electron neutrino, generation 2 leptons are the muon and muon neutrino, and generation 3 leptons are the tau and tau neutrino. The first generation fermions are the lightest, most stable, and

have the longest lifetimes. The third generation fermions are the heaviest, least stable, and have the shortest lifetimes. All of the quarks have both electric charge and color charge. Electrons, muons, and taus have an electric charge of -1, but they do not have a color charge. The neutrinos are neutral and have very small mass.

Composite particles can be formed from quarks and leptons. Mesons (e.g. pions, etc.) are made of one quark and one antiquark. Since quarks have half-integer spins, mesons are also bosons. Baryons are made of three quarks, thus baryons are also fermions. Mesons and baryons are also hadrons, where a hadron is any particle with quarks as its constituent parts. Hadrons can either be stable or unstable. Other composite particles (neither mesons nor baryons) exist that can be stable or unstable. For example, most isotopes of elements are unstable.

Bosons are also called gauge bosons. Gauge bosons are the virtual messengers of the four fundamental interactions. In other words, the gauge bosons are the force carriers. The four fundamental interactions are the following: electromagnetic force, weak force, strong force, and gravity. The gauge boson for the electromagnetic force is the photon. The electromagnetic force is passed through the  $W^\pm$  gauge bosons. The weak force is passed through the  $W^\pm$  gauge bosons as well as the neutral  $Z^0$  gauge bosons. The strong force is passed through gluons. The strong force affects particles with color.

The Standard Model is not a complete model in that gravity is not included. The Standard Model predicts the unobserved Higgs Boson and the Higgs Boson will provide an explanation of why particles have mass. The graviton is said to be the force carrier particle for gravity. The Higgs boson is not a gauge boson, but it is classified as a boson since theory predicts it to have an integer spin of 0. The Standard Model is depicted in Fig. 1. [1][2][3]

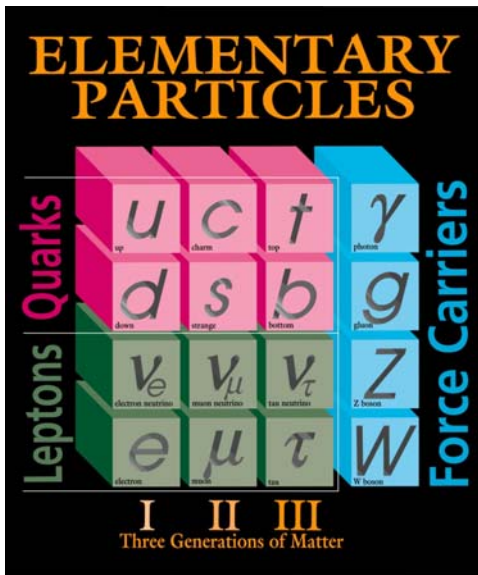

Fig. 1: The Standard Model of Particle Physics

## II. FERMILAB AND THE CDF EXPERIMENT

Fermilab, located in Batavia, Illinois, houses the Tevatron, which is a very powerful circular accelerator with a radius of 1.0 km. The Tevatron has the ability to take samples of protons and antiprotons and give them as much energy as 980 GeV. The protons and antiprotons are traveling at 99.99999954 percent the speed of light in a circular pipe a few centimeters in diameter. The travel path is adjusted by strong magnetic fields. The protons and antiprotons are adjusted to collide at the Collider Detector at Fermilab (CDF) every 396 ns. When protons and antiprotons collide, interesting events take place in which a slew of particles can form. A quark or a gluon in a proton and an antiquark or a gluon in an antiproton collide at high energy, and the energy produced is available to become massive particles since mass and energy are interchangeable. See Fig. 2 for an aerial view of the Tevatron.



Fig. 2: Aerial View of the Tevatron at Fermilab

The CDF detector is about three stories tall and weighs approximately 5000 tons. The detector is designed to extract

information from these proton-antiproton collisions. To detect newly formed particles, the detector is composed of many subdetectors arranged in layers. One subdetector is the Central Outer Tracker (COT), shown in yellow in Fig. 3. The COT contains a flammable gas which is a 50/50 mixture of argon and ethane. The gas atoms are ionized by the charged particles, and these gas ions drift to the sense wires. There are 8 superlayers of these wires, and in each superlayer there are cells that contain 12 wires. After an event, the signals from the outer tracker are inputted into the XFT, and the final step is to determine if there is a particle track. If there is a particle track, its momentum is extracted. See Fig. 3 for a more detailed view of the COT.

Another subdetector is the calorimeter, shown in blue in Fig. 4. The calorimeter is divided into “towers” that point toward the location of the proton-antiproton collision. Any particle that results from the collision and is electrically charged, the calorimeter will measure that energy and a track will be seen in the COT. Any particle that results from the collision and is electrically neutral, the calorimeter will measure that energy and there will be a distinct absence of track in the COT. [4][5]



Fig. 3: Detailed View of the COT

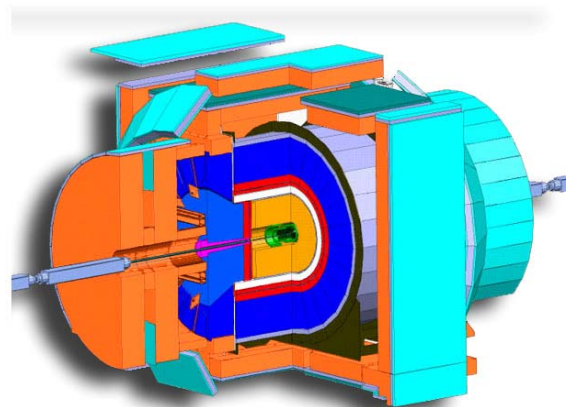

Fig. 4: Central Detector at Fermilab (CDF)

## III. PHOTON + JET EVENTS

The data analyzed in this research is from proton-antiproton

collisions recorded at the CDF experiment between April 2005 through August 2007 and the amount of data is  $2 \text{ fb}^{-1}$ . The data are compared to predictions of the Standard Model using a Monte Carlo simulation of photon production using PYTHIA. The Monte Carlo program simulates a collision and chooses at random the number of jets and the jet energy, within certain constraints and certain probabilities.

The photons in this research are called tight photons. These photons have been through a series of strict selection requirements. Background photons are removed in the process. A background photon would be a particle that seems to mimic a photon's behavior in the detector, but is not an actual photon.

The Standard Model predicts that a small fraction of proton-antiproton collisions will produce an energetic photon plus one or more quarks and gluons. Experimentally, these photons can be detected by looking for energy deposited in the calorimeter. The difference between photons and other particles is that photons have no electric charge and there is a distinct absence of any charged particle tracks in the COT tracking chamber. Quarks and gluons that emerge from the collision undergo a process called fragmentation, leading to the formation of narrow 'jets' of particles. The jets are what appear in the detector. [2][3][6]

#### IV. DATA ANALYSIS

For this research, a program was written in order to analyze the CDF data and the Monte Carlo simulations, and compare how well the Standard Model predicts experimental measurements. The program was written in ROOT, which is a C++ framework for data processing. At the CDF experiment, a standard coordinate system is defined in which the x axis is radially outward from the center of the Tevatron, the y axis is upward, and the z axis is in the direction that protons travel in the Tevatron. The following are a few basic quantities that were measured using the detector: energy and direction of the photons, energy and direction of the jets, and the distribution of jet energy in adjacent calorimeter towers. Based on these measured quantities, the components of momenta of jets and photons were found. The program calculated and/or produced the following: jet energy using the values measured from the calorimeters and generated using Monte Carlo, the smallest angle between a photon and a jet for events with one photon and one jet, the azimuthal angle for photons, the transverse momentum of the photon and the transverse momentum of the leading jets in each photon event. In this event sample, the photon  $P_T$  is greater than  $30 \text{ GeV}/c$  and jet  $P_T$  greater than  $15 \text{ GeV}/c$ . Equation 1 and 2 were used to calculate the transverse momentum for the photons and jets.

$$\text{Jet } P_T = \sqrt{P_x^2 + P_y^2} \quad (1)$$

$$\text{Photon } P_T = \sqrt{P_x^2 + P_y^2} \quad (2)$$

#### V. RESULTS

In the following figures, the Standard Model prediction has been scaled to the same area as the CDF data in order to compare the shapes of the distributions. The histogram for the angle between the photon and jet for events with one jet can be seen in Fig. 4. For most events the angles are near  $180^\circ$ , which should be the case since momentum must sum to zero in the transverse plane. However, the data do not agree completely with Standard Model predictions.

The histogram for the azimuthal angle of photons can be seen in Fig. 5. The narrow gaps in the histogram are due to regions in which there are cracks between the wedges of the calorimeter, not because photons cannot have those angles. Photons can have any azimuthal angle.

The histogram for the energy of all jets in photon events can be seen in Fig. 6. The curving at the top of the distribution is due to the photons having transverse momenta greater than  $30 \text{ GeV}/c$  and the jets having transverse momenta greater than  $15 \text{ GeV}/c$ . Most importantly about this histogram, is that the CDF data and Standard Model agree extremely well over several orders of magnitude. However, in Fig. 7, we can see that on a linear scale the data do not agree as well at low values of jet energy. This is most likely due to the large uncertainty in measuring low values of jet energy.

The histogram for the transverse momentum of the leading jet in photon events can be seen in Fig. 8. The data agree very well with Standard Model predictions over several orders of magnitude. In Fig. 9, on a linear scale, the data disagree slightly with the Standard Model at low values of jet transverse momentum.

The histogram for the transverse momentum of photons in photon events can be seen in Fig. 10. The data do not agree as well with Standard Model predictions, most likely because there is an excess of events at low values of transverse momenta due to background. Dijet events in which a jet fakes a photon tend to be concentrated in this region.

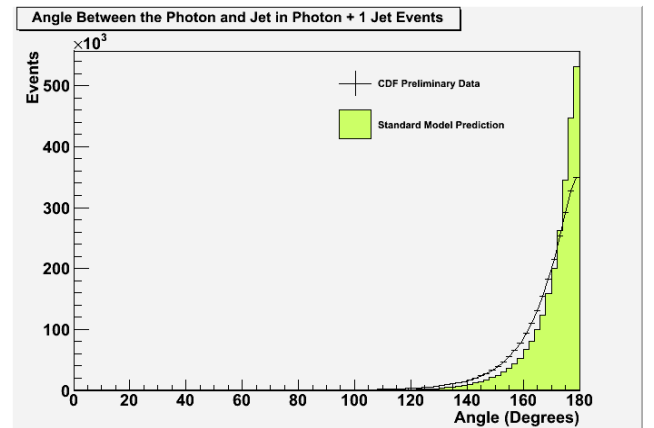

Fig. 4: Distribution of the smallest angle between the photon and jet for events with one jet.

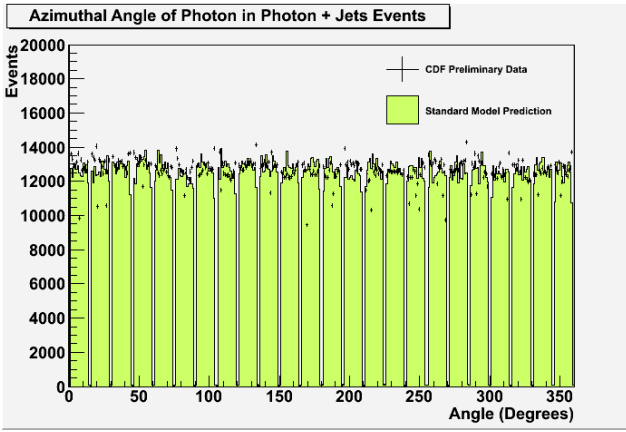

Fig. 5: Distribution of the azimuthal angle of the photon in photon + jet events.

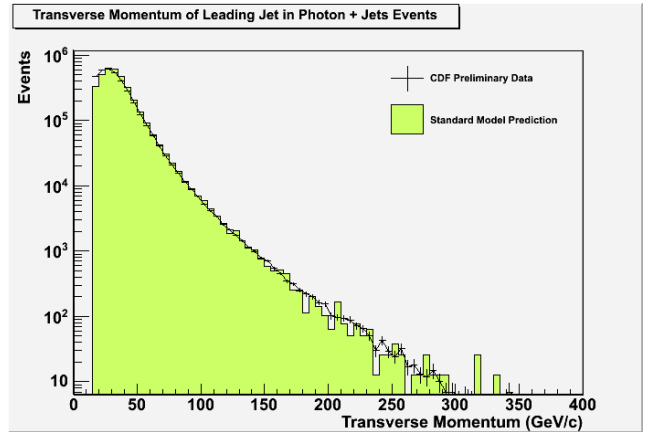

Fig. 8: Distribution of the transverse momentum of the leading jet in photon + jets events (log scale).

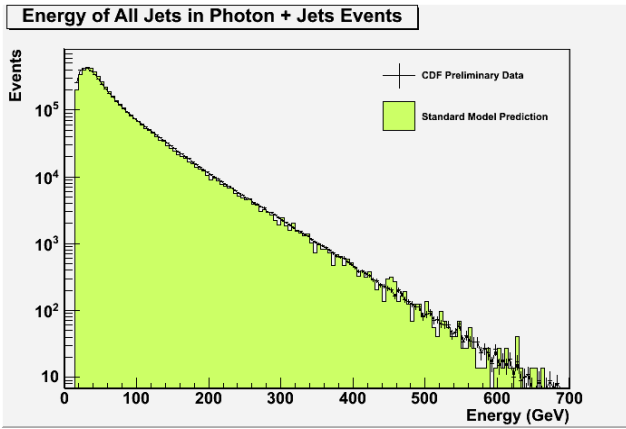

Fig. 6: Distribution of the energy of all jets in photon + jet events (log scale).

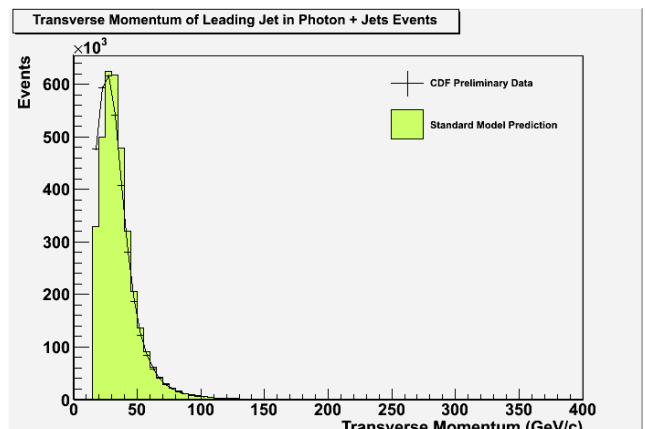

Fig. 9: Distribution of the transverse momentum of the leading jet in photon + jets events (linear scale).

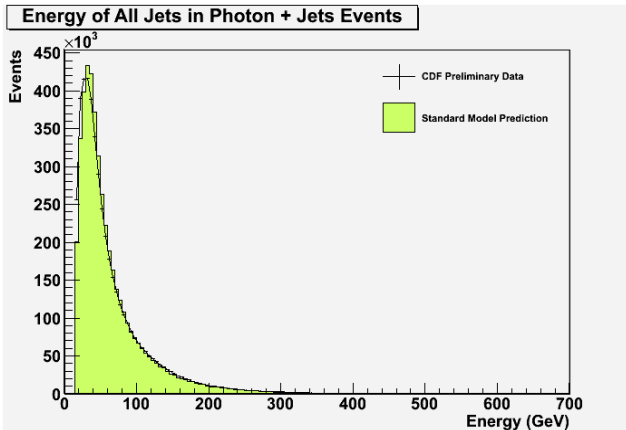

Fig. 7: Distribution of the energy of all jets in photon + jets events (linear scale).

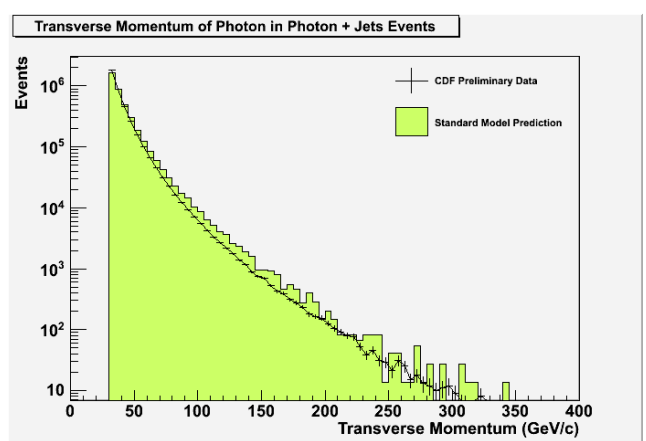

Fig. 10: Distribution of the transverse momentum of the photon in photon + jets events (log scale).

## VI. CONCLUSION

Events with photons have been collected at the Fermilab Tevatron Collider and the properties of photon + jet events have been compared with the Standard Model. The CDF data and Standard Model agree very well, although there are some differences. Some of the differences can be due to the

possible background events in the photon + jet data sample.

#### ACKNOWLEDGMENT

This work was performed in part at Baylor University, which is supported by the National Science Foundation and the Center for Astrophysics, Space Physics, and Engineering Research grants. Thank you Fermilab, Dr. Lorin S. Matthews, Dr. Truell W. Hyde, Karen Bland, Martin Frank, Samantha Hewamanage, and Dr. Jay R. Dittmann.

#### REFERENCES

- [1] M. Robinson, K. Bland, G. Cleaver, and J. Dittmann, "A simple introduction to particle physics", BU-HEPP-08-20, Oct 2008. 139 pp.
- [2] R. Dunlap, "An Introduction to the Physics of Nuclei and Particles", Brooks/Cole, a Division of Thompson Learning, 2004, pp. 199-221.
- [3] K. Bland, Baylor University, Waco, TX, private communication, June 2009.
- [4] J. Dittmann, Baylor University, Waco, TX, private communication, June 2009.
- [5] The CDF Collaboration. The CDF II Detector Technical Design Report. Fermi National Accelerator Laboratory, 1996.
- [6] F. Abe *et al.* (The CDF Collaboration), Phys. Rev. D **52**, 4784 (1995).